

# PLX1176 - KLX1176

PORTAVALIGIE LATERALE SPECIFICO - SPECIFIC TUBULAR SIDE-CASE HOLDER - PORTE-VALISES LATÉRAUX SPÉCIFIQUE  
 SPEZIFISCHES STAHLROHR-SEITENTRAEGER - PORTA MALETAS LATERALES ESPECÍFICO - TRONCO LADO ESPECÍFICO

## HONDA CB500F (2019)

N°	Descrizione	Caratteristiche	Codice	Quantità
1	Telaio laterale - Side frame - Châssis latéral - Soporte lateral - Seitenrahmen - Suporte lateral	-	PLX1176DXV PLX1176SXV	2 (Right; Left)
2	Ponte Posteriore - Rear Bridge - Pont Postérieure Verbindungsrohr - Puente Trasero - Ponte Traseira	-	GNB1604V	1
3	Deviatore Gas Di Scarico - Exhaust Gas Diverter Embout Derivation Gaz Echappement - Desviador De Gas De Escape Abgasableiter - Desvio De Gás Do Tubo De Escape	-	GNB2313T	1
4	Supporto inferiore - Lower support Support inférieur - Soporte inferior Untere Halterung - Suporte inferior	-	GNB2357V	1
5	Vite - Screw Vis - Schraube Tornillo - Parafuso	TBEI M8x60	860TBEI	2
6	Vite - Screw Vis - Schraube Tornillo - Parafuso	TBEI M8x35	835TBEI	4
7	Vite - Screw Vis - Schraube Tornillo - Parafuso	TBEI M8x16	816TBEI	3
8	Rondella - Washer - Rondelle Scheibe - Arandela - Arruela	Foro Ø8mm / Esterno Ø14mm	814RON	6
9	Rondella - Washer - Rondelle Scheibe - Arandela - Arruela	Foro Ø8mm / Esterno Ø14mm Sp.2mm	820RON	1
10	Rondella spaccata - Split washer Scheibe - Rondelle fendue Arandela seccionada - Arruela Dentada	Foro Ø8mm	Z1060	4
11	Dado - Bolt - Ecrou Mutter - Tuerca - Porca	-	V423	1
12	Dado - Bolt - Ecrou Mutter - Tuerca - Porca	Auto Bloccante Flangiato Ribassato M8	8DADIFN	5
13	Particolari Inclusi nel 1176FZ Components Included In The 1176FZ Pièces Incluses Dans 1176FZ Die Einzelnen Teile Sind Bei 1176FZ Despieces Incluidos En El 1176FZ Componentes incluidos na 1176FZ	-	-	-
14	Particolari Inclusi nel 1152KIT Components Included In The 1152KIT Pièces Incluses Dans 1152KIT Die Einzelnen Teile Sind Bei 1152KIT Despieces Incluidos En El 1152KIT Componentes incluidos na 1152KIT	-	-	-
15	Componenti Originali - Original Parts Parties Originales - Original Bauteile Componentes Originales - Componentes Originais	-	-	-

# PLX1176 - KLX1176

PORTAVALIGIE LATERALE SPECIFICO - SPECIFIC TUBULAR SIDE-CASE HOLDER - PORTE-VALISES LATÉRAUX SPÉCIFIQUE  
SPEZIFISCHES STAHLROHR-SEITENTRAEGER - PORTA MALETAS LATERALES ESPECÍFICO - TRONCO LADO ESPECÍFICO

## HONDA CB500F (2019)

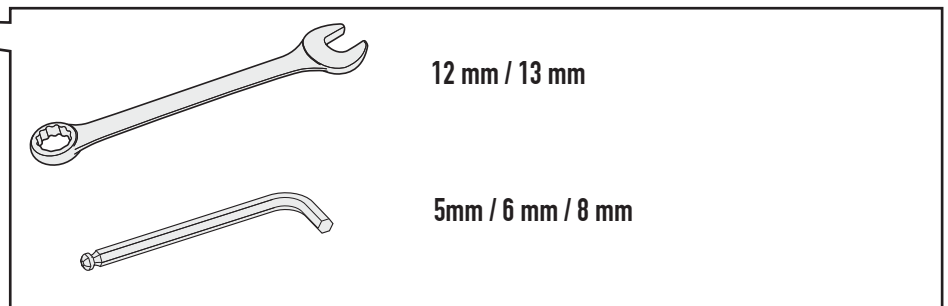
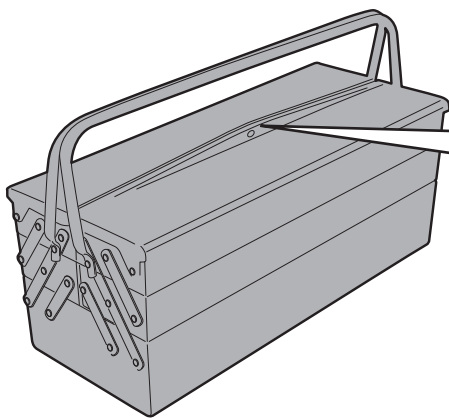
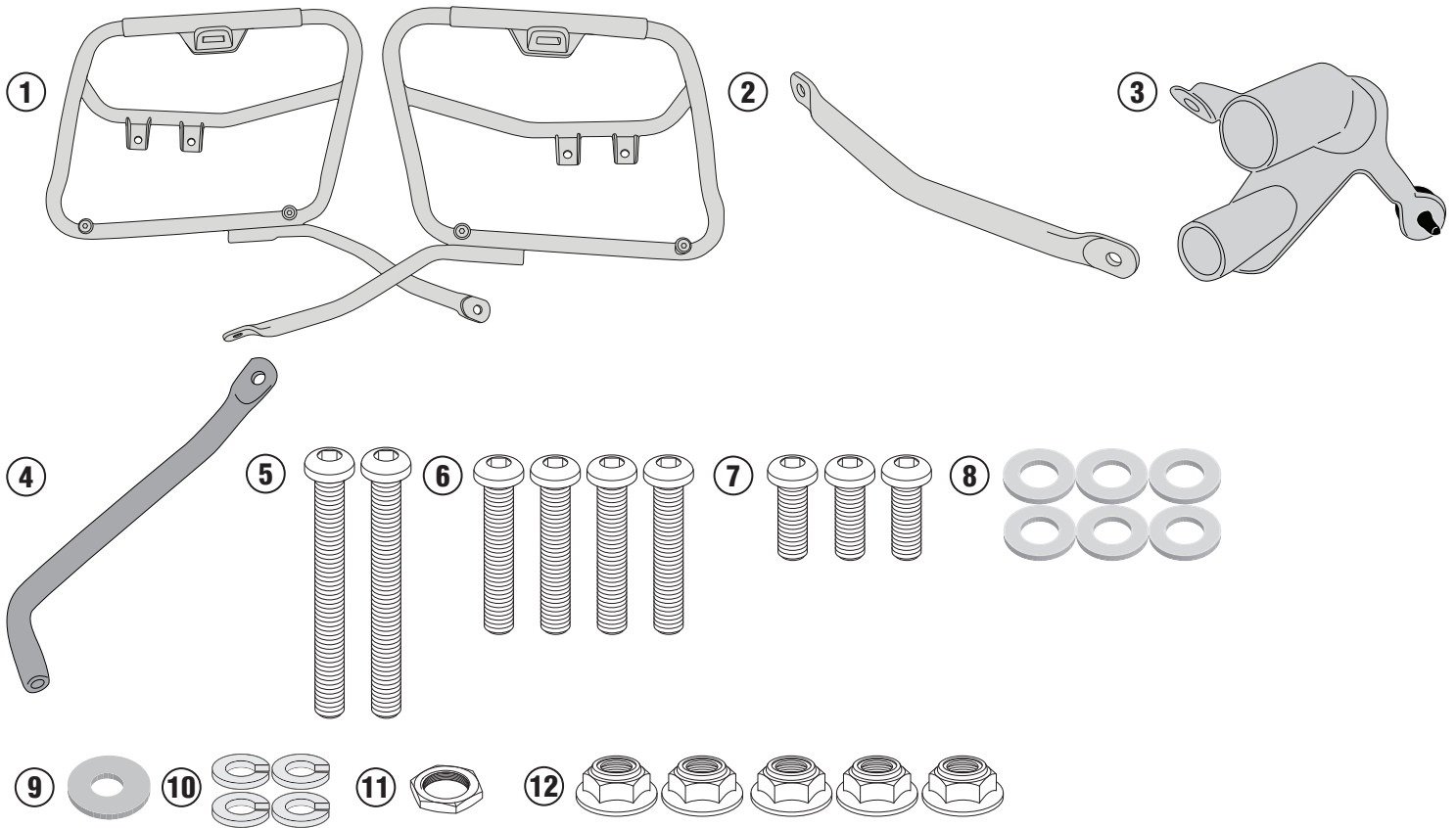

# PLX1176 - KLX1176

PORTAVALIGIE LATERALE SPECIFICO - SPECIFIC TUBULAR SIDE-CASE HOLDER - PORTE-VALISES LATÉRAUX SPÉCIFIQUE  
SPEZIFISCHES STAHLROHR-SEITENTRAEGER - PORTA MALETAS LATERALES ESPECÍFICO - TRONCO LADO ESPECÍFICO

## HONDA CB500F (2019)

### 1152KIT+PLX1176

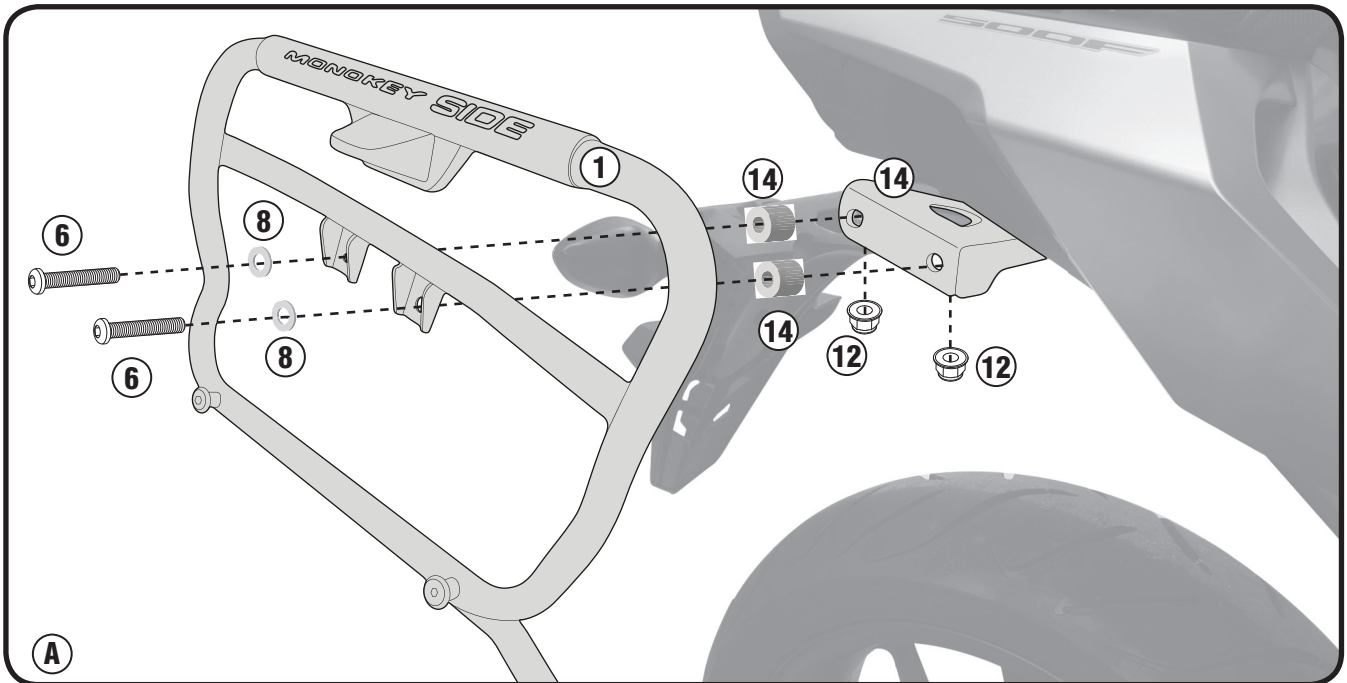

### 1176FZ+PLX1176

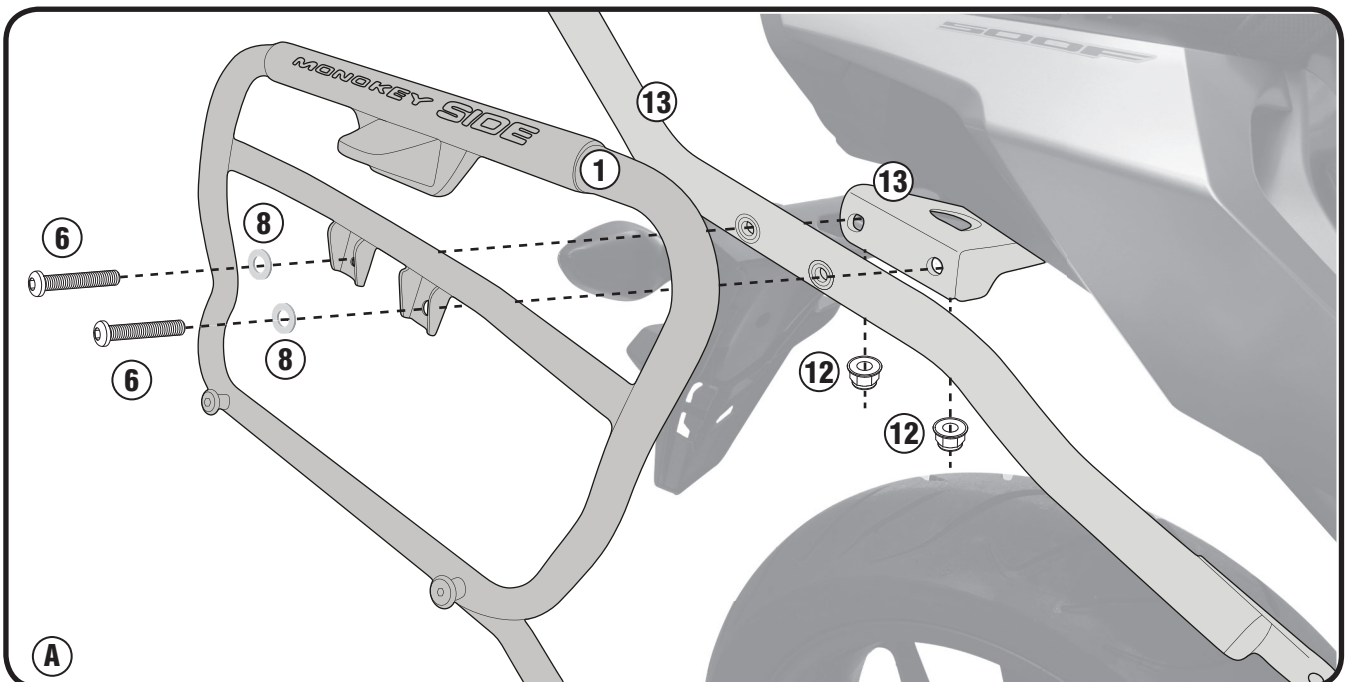

# PLX1176 - KLX1176

PORTAVALIGIE LATERALE SPECIFICO - SPECIFIC TUBULAR SIDE-CASE HOLDER - PORTE-VALISES LATÉRAUX SPÉCIFIQUE  
SPEZIFISCHES STAHLROHR-SEITENTRAEGER - PORTA MALETAS LATERALES ESPECÍFICO - TRONCO LADO ESPECÍFICO

## HONDA CB500F (2019)

### RIGHT SIDE

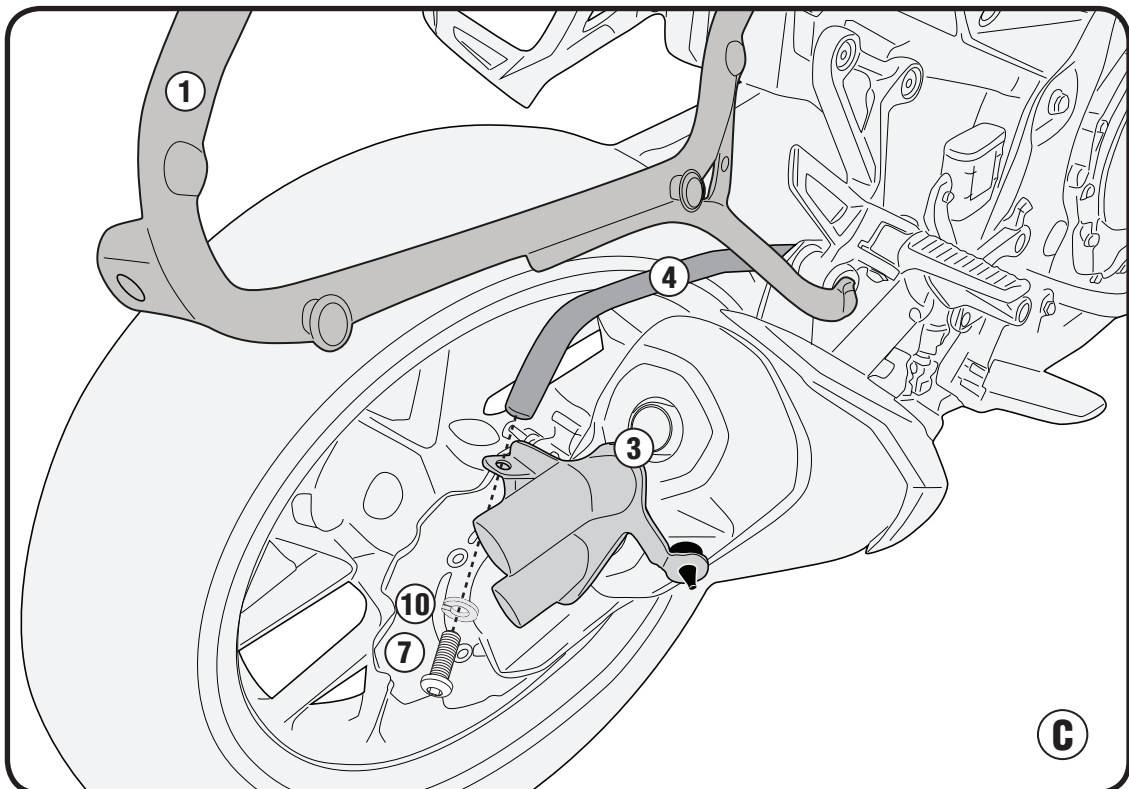
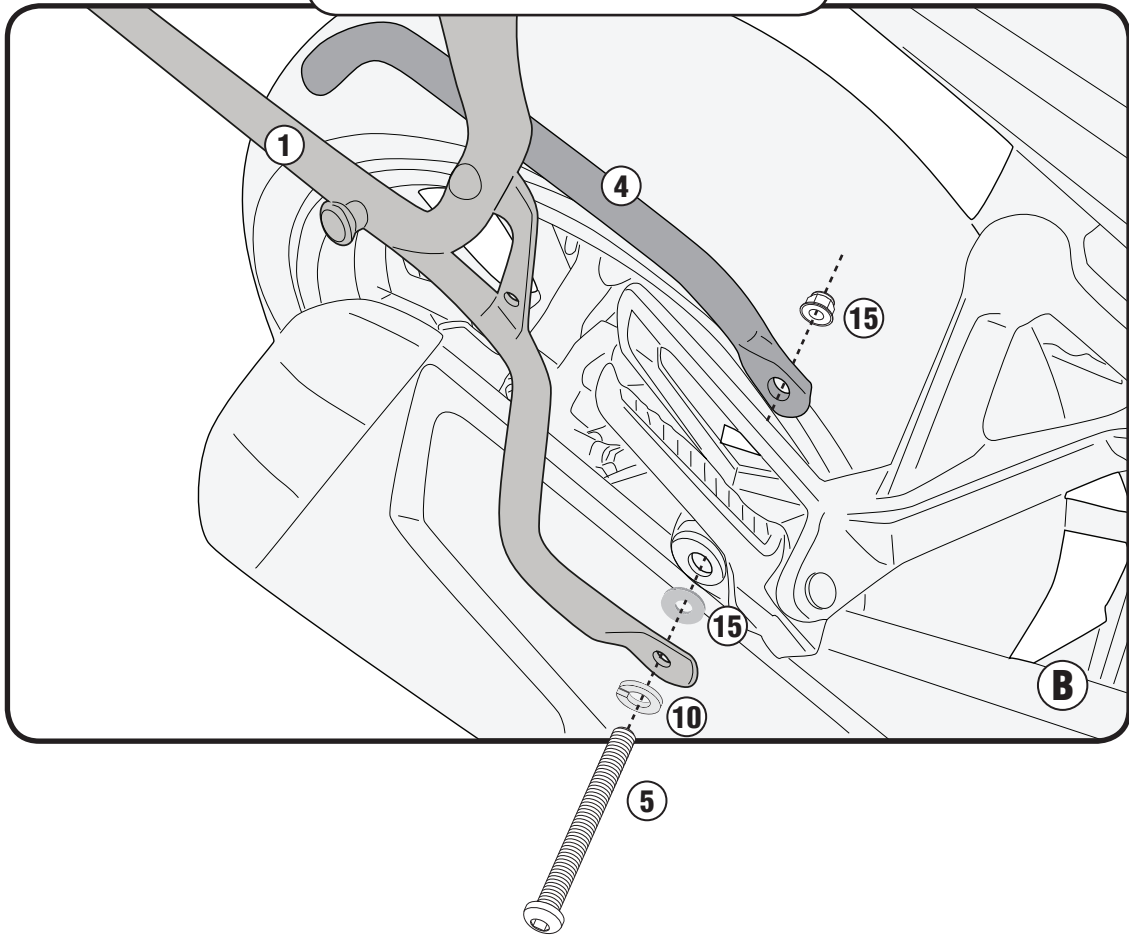

ISTRUZIONI DI MONTAGGIO - MOUNTING INSTRUCTIONS  
INSTRUCTIONS DE MONTAGE - BAUANLEITUNG  
INSTRUCCIONES DE MONTAJE - INSTRUÇÕES DE MONTAGEM

# PLX1176 - KLX1176

PORTAVALIGIE LATERALE SPECIFICO - SPECIFIC TUBULAR SIDE-CASE HOLDER - PORTE-VALISES LATÉRAUX SPÉCIFIQUE  
SPEZIFISCHES STAHLROHR-SEITENTRAEGER - PORTA MALETAS LATERALES ESPECÍFICO - TRONCO LADO ESPECÍFICO

## HONDA CB500F (2019)

### LEFT SIDE

